

” Your partner
for a sustainable
rearing.



URBAN MILKSHUTTLE

The professional calf drink mixer



For a sustainable rearing

Innovative technologies for the barn of the future.

It all started with an innovative idea of Helmut Urban more than 35 years ago.

In his passion for agriculture, the welfare of the animals has always been Helmut Urban's first priority. After all, only a healthy calf provides a secure basis for the future of a dairy farm. This principle gave rise to the idea of technical automation and thus species-appropriate feeding for calves. This idea is the basis of our developments and brings the work relief for the farmer and the health of the animals in harmony.

In 1992 the company Urban moved to the industrial area in Wüstring, whereupon we developed to one of the specialists in feeding technology for calves and lambs. Over the years, we have been able to expand our product portfolio. With the automatic calf feeder Alma Pro, as well as the Milkshuttle, we have leading product lines on the market in the area of stationary and mobile young animal feeding.

Thanks to our in-house development and production, the highest standard of our products is guaranteed. Meanwhile we export our products to more than 60 countries all over the world and the demand is constantly increasing. With modern and precise approaches we develop innovative technologies for the barn of the future. For this purpose we are in regular exchange with farmers and experts.



Our motivation is to make everyday work for farmers as efficient as possible.





URBAN MILKSHUTTLE

The professional calf drink mixer

BENEFITS



Electric drive

Ensures effortless transport of the milk even over inclines, rough terrain, steps or ice and snow.

Easy dispensing

The ergonomically shaped feeding nozzle dispenses the milk for your calves effortlessly. Three different dosing quantities are programmable.

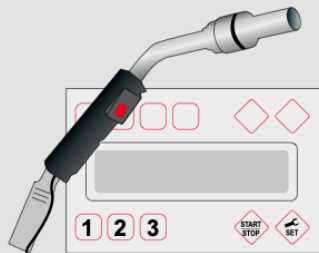

Different volumes

In different versions available - from 100 to 350 liters capacity.



2-stage agitator

For whole milk or milk replacer.

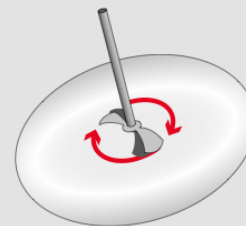

Automatic stop

Prevents sudden rolling away and ensures a safe parking position.



Extremely small turning circle

With a radius of only 1.72 meters, the MilkShuttle is extremely maneuverable and also suitable for small stable buildings.

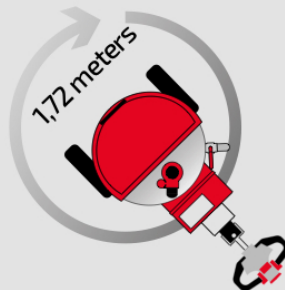

Optional: Integrated pasteurisation function

For easily digestible milk feeds.

” Our equation for comfortable calf feeding:

Feed 30 calves per bucket = 25 minutes

Feed 30 calves by Urban MilkShuttle = 11 minutes.

This leaves more time for other things!



More interesting information and worth knowing:





SET UP

Get an overview.

In the following you will find an overview of the most important components of the MilkShuttle.



THE URBAN MILKSHUTTLE

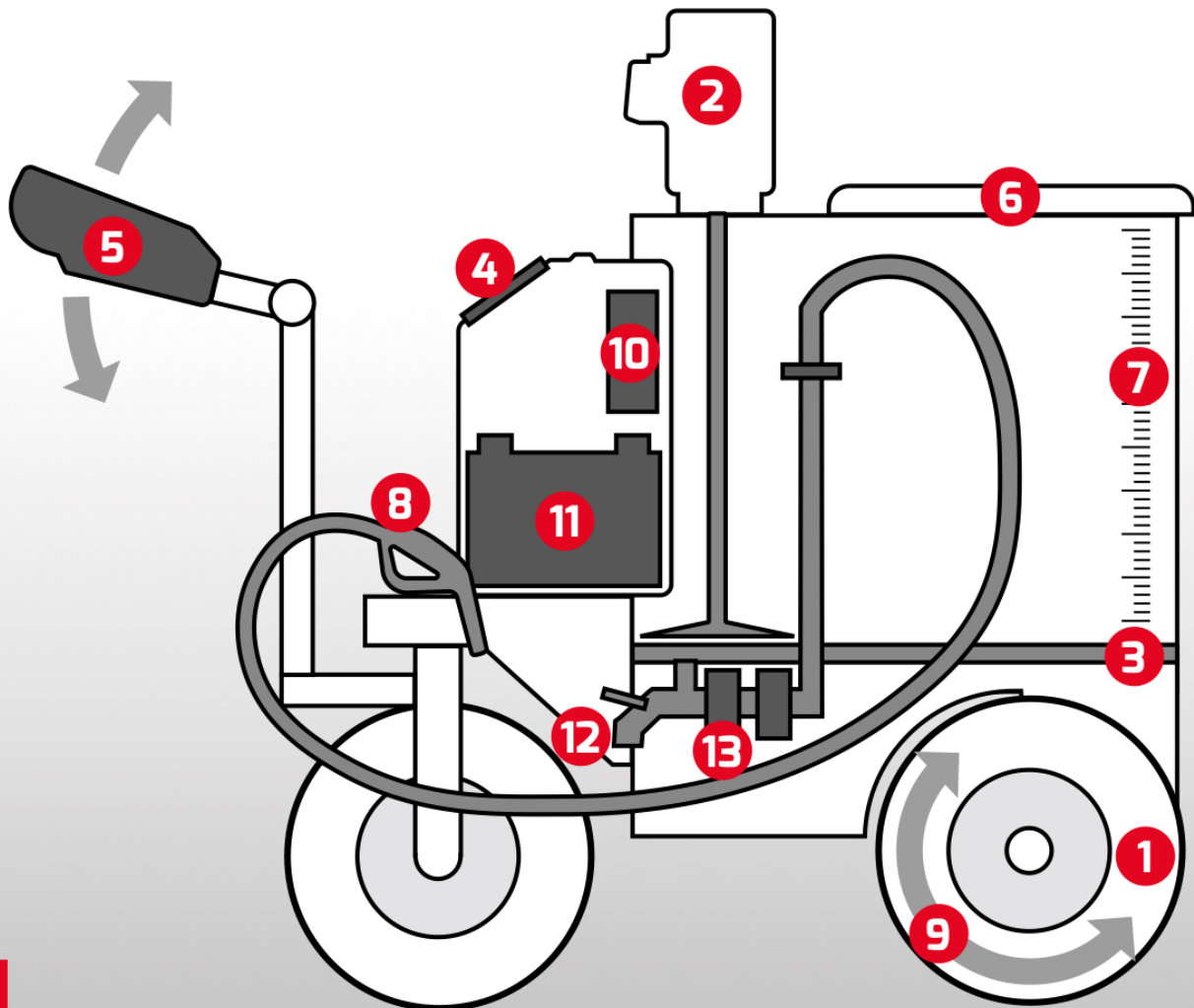

6

- 1** Three puncture-proof and large wheels (diameter: 40 cm) provide the necessary stability and excellent driving comfort.
- 2** Almost noiseless agitator.
- 3** Built-in floor heating. Optionally, also a cooling unit can be installed (MilkShuttle pasteurizer).
- 4** Clearly and simply structured control panel.
- 5** Ergonomically designed handle for easy navigation, even on rough or sloping terrain.
- 6** Cover with seal and closure - this keeps the milk safely protected.
- 7** Practical quantity scale in the container to allow easy preparation of the correct mixture.
- 8** Nozzle with ergonomically shaped handle for easy filling of buckets.
- 9** Stepless, electric drive - forwards and backward.
- 10** Power electronics / main safety switch removable
- 11** Two powerful rechargeable batteries
- 12** 1.5" drain valve
- 13** Pump (battery-powered)





DIFFERENT MODELS

A suitable MilkShuttle for every farm and every requirement
- that's our mission.

We have succeeded that mission with five MilkShuttle sizes and various options.

CONTAINER SIZES

From the smallest MilkShuttle with a capacity of 100 liters up to the XXL variant with a volume of 350 liters
- our basic models are daily helpers that perfectly suit on your farm.

We will be pleased to advise you on your selection.



PASTEURISATION FUNCTION

Pasteurisation process

Pasteurisation reliably kills germs and bacteria by heating the milk. The milk becomes more digestible for your calves and diarrhoea problems are avoided. The holding temperature can be adjusted individually - gentle pasteurisation is also possible. Cooling takes place via the intermediate floor - even small quantities can be cooled, resulting in minimal energy loss.

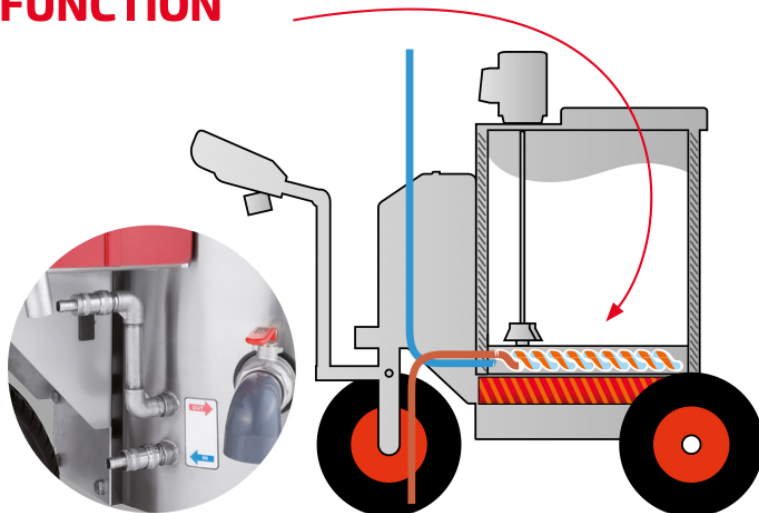



**MORE CAPACITY –
SAME MANEUVERABILITY.**

350
Litres



The new container holds a volume of up to 350 liters and is still compact, so that it fits through any door.

Among the most serious innovations, are the larger tires, which are based on a highly elastic plastic core.

They ensure optimum stability thanks to their high weight, but still retain none of the usual maneuverability.

The tires are, as with all Urban MilkShuttles, puncture-proof and maintenance-free. Uneven surfaces, uphill and downhill gradients, weather conditions - external factors become almost insignificant due to the puncture-proof tires.





STANDARD EQUIPMENT

Our mission: To develop easy-to-use, clearly designed helper for the daily work routine.

The Urban MilkShuttle is convincing with its simple construction and extremely robust components.

Electric drive

The traction drive is infinitely variable and has both forward and backward gears. So you can reach your calves comfortably.

Comfortable dispensing

By means of a metering pump and dispensing nozzle, the calves get exactly the quantity of feed that is to be given.

The desired quantity of milk can be preset and then filled in via a button on the dispensing nozzle.

Computer controlled dispensing

The milk can be drawn quickly and accurately in 0.1-liter amounts. Three previously programmed dispensing quantities can be selected. Even large containers can be filled using a special function.



● Dispensing nozzle with integrated check valve. Easy to disassemble and to clean.

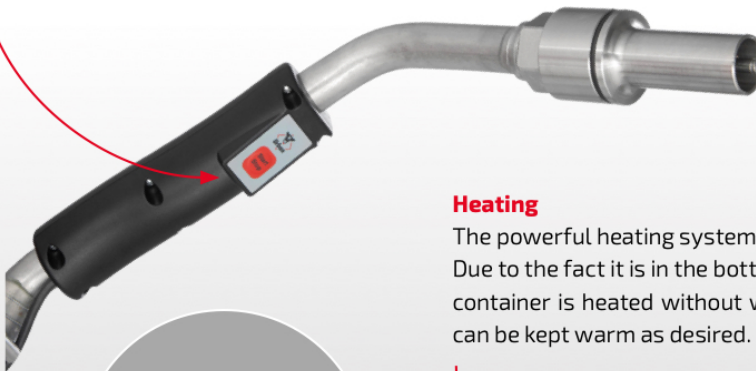

Heating

The powerful heating system works extremely efficiently. Due to the fact it is in the bottom of the milk shuttle, the liquid in the container is heated without wasting energy. Once heated, the milk can be kept warm as desired.



● Button on drawbar





- Puncture proof - Our wheels are made of a highly elastic plastic core. So they are puncture-proof and service-free. Furthermore, the indestructible wheels stabilize the all-terrain Urban MilkShuttle.

2-stage agitator

To create a homogeneous feed, the stages of the agitator can be manually selected. Thus they are suitable for whole milk and milk replacer.

The slow stage to gently mix whole milk during heating - the interval control ensures that the milk does not burn. The fast stage provides lump-free mixing of the milk replacer.



- In a short time the milk is heated and can be fed.



- The LED headlight provides better visibility in dark surroundings.

The control terminal

The control terminal of the Urban MilkShuttle is clearly laid out and easy to operate. The various programmes can be selected using the buttons. All relevant data, such as the battery charge level, are displayed transparently.



- Three different start times for heating the milk are freely programmable.



NEWS

Stainless-steel pipe with preparation for a drench connection is now standard



Main safety switch removable and socket for accessories - standard



Worklight

As an option, the worklight serves to improve the illumination of your working area to increase efficiency and safety at work.

Toolbox - Everything at hand!

The practical toolbox allows you to always have the additionally requires at hand.





not available for MS 350

URBAN EcoProtector^{UV-C}

- **Urban EcoProtector^{UV-C}** vertically mounted for the disinfection of hutches and wall surfaces



- **Urban EcoProtector^{UV-C}** mounted horizontally for fast and chemical-free surface disinfection



Hygiene

is becoming increasingly important on farms, but disinfection is usually labour- and chemical-intensive. With the **Urban EcoProtector^{UV-C}**, which can be attached to the new shuttle generation, you can disinfect hutches and any other surfaces on farms quickly without chemicals.



The **Urban EcoProtector^{UV-C}** was developed for disinfecting calf hutches and any surfaces. Placed in front of a roughly pre-cleaned hutch, more than over 90 % of all germs are killed after 2 minutes of exposure to UV-C light. Longer irradiation times kill correspondingly more germs. A simple slow pass over a swept floor kills 90% of all germs present there. This is particularly true for the cryptosporidia, which are highly sensitive to UV-C, which are responsible for most of the diarrhea.

Germ pressure in the hutch before and after irradiation with the **Urban EcoProtector^{UV-C}**



The **Urban EcoProtector^{UV-C}** is easy to operate via the display of your Urban MilkShuttle. It automatically recognizes whether floors or hutches are to be disinfected and directly suggests the optimum irradiation time or driving speed.

The **Urban EcoProtector^{UV-C}** has 4 powerful, shatter-proof UV-C tubes. Even if one lamp breaks, you do not have to fear glass splinters the animals' environment.





ACCESSORIES



Vacuum lid for easy filling with fresh milk.

The milk is sucked out of the milk cans or milk tanks into the Urban MilkShuttle.

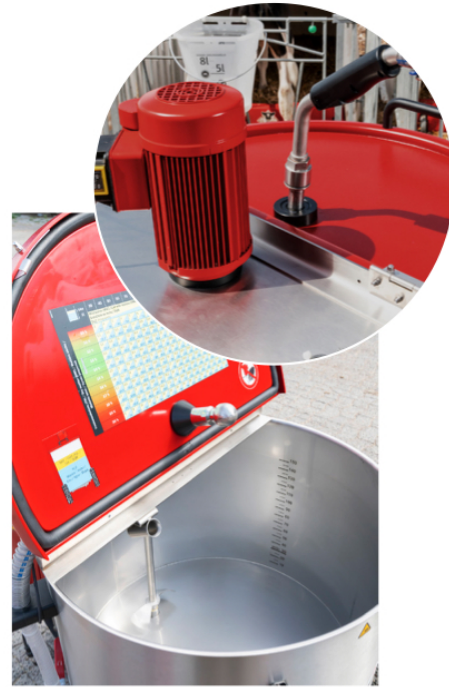

Cleaning nozzle

The MilkShuttle is automatically cleaned and an additional manual operation is not needed anymore.



Insulation

Keeps the milk at the desired temperature for a long time – saving energy!



Removable accessories holder

Handy holder for milk cans, feeding bowls or feed buckets.



not available for MS 350

Caddy

This trailer has space for up to 24 feeding buckets, milk cans as well as for several accessories like water, food or medication. The feeding buckets can be hung upside down on the hooks, so that they can dry after cleaning.



● Holder for the bucket carrier

Bucket holder

Up to 16 feeding buckets can be conveniently transported with the bucket carrier and can be hung upside-down for drying.

Trailer coupling

With the trailer coupling you can simply attach a trailer - for example the Urban Caddy - to the MilkShuttle.



Drench-connection

For attaching a cow drencher to the MilkShuttle.





URBAN MILKSHUTTLE

URBAN MilkShuttle

TECHNICAL DATA



100 L

150 L

200 L

250 L

350 L

Top View

Front view

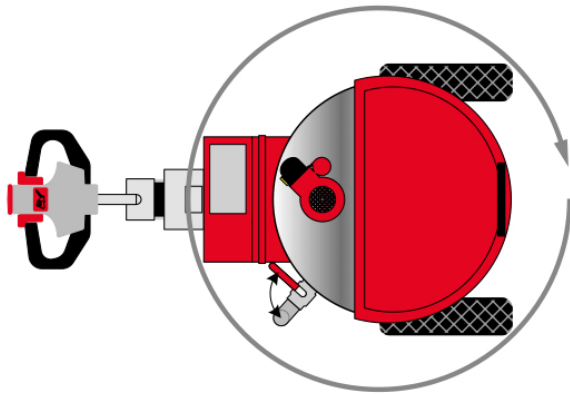

Urban MilkShuttle 100, 150, 200, 250:
1,72 m

Urban MilkShuttle 350:
2,18 m

Urban MilkShuttle 100:
80 cm
Urban MilkShuttle 150, 200, 250:
82 cm
Urban MilkShuttle 350:
92 cm



Side view

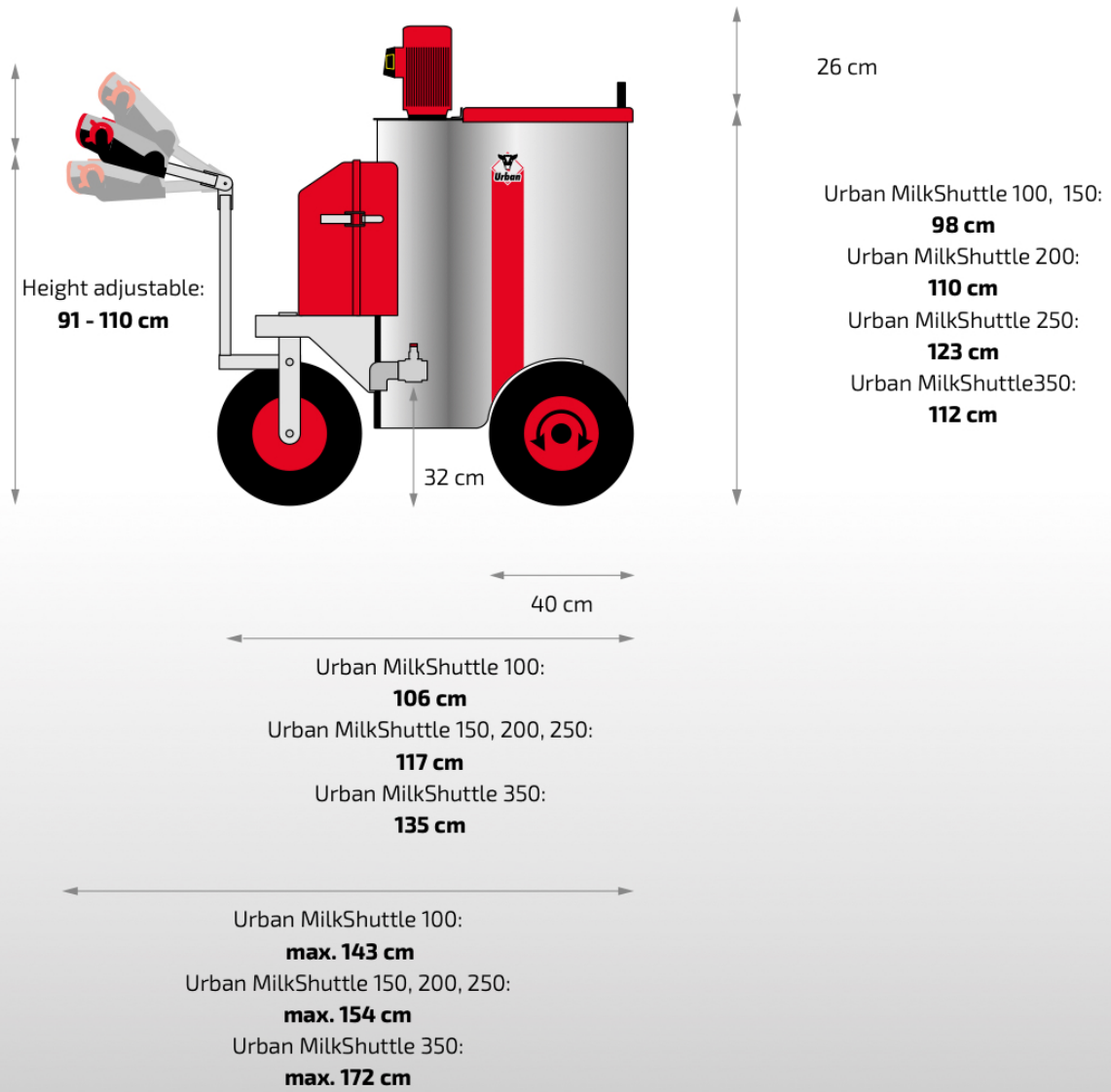



URBAN VITALCONTROL

The professional equipment
for improved animal health

The newly engineered VitalControl is compatible with the Alma Pro. The collected values are assigned to the respective calf by the scan function. This provides a well-founded animal evaluation and allows detecting possible illnesses earlier.

VitalControl creates alarm lists based on the collected data, conspicuous animals are shown in simple diagrams based on body temperatures and general state of health.

”

This is what modern, digital animal data collection of today looks like!

Dr. Andreas Deininger

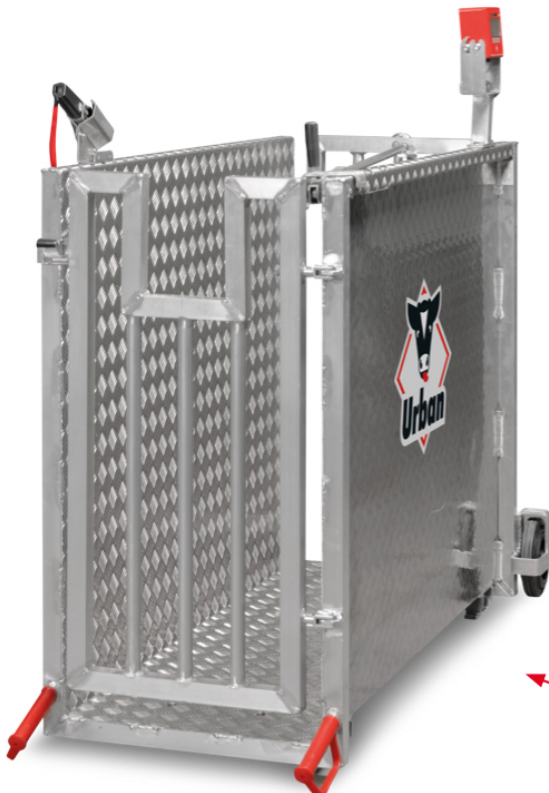

The Urban Mobile Calf Scale

Practical and tailored to your needs.
Add the weight of the animals to your data with the help of the Urban calf scale.

DETAILS

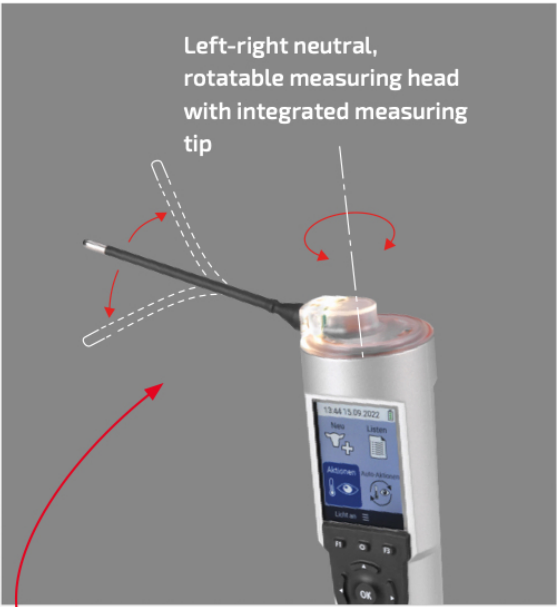

Long, stepped, flexible, deflectable measuring tip made of flexible, tissue-friendly material



URBAN ALMA PRO

URBAN ALMA PRO



**The intelligent calf feeder
for automatic calf feeding .**



Create functional, operation - specific solutions

Our automatic feeder is suitable for for small and large groups and can be individually adapted depending on the application.



Mobile control – optional

By pairing the device with the Urban Wi-Fi router you can use all functions of the Urban Alma Pro with smart device or PC - from the monitoring to the setting.



URBAN CALF HUTCH



Optimal support for outdoor calf rearing.

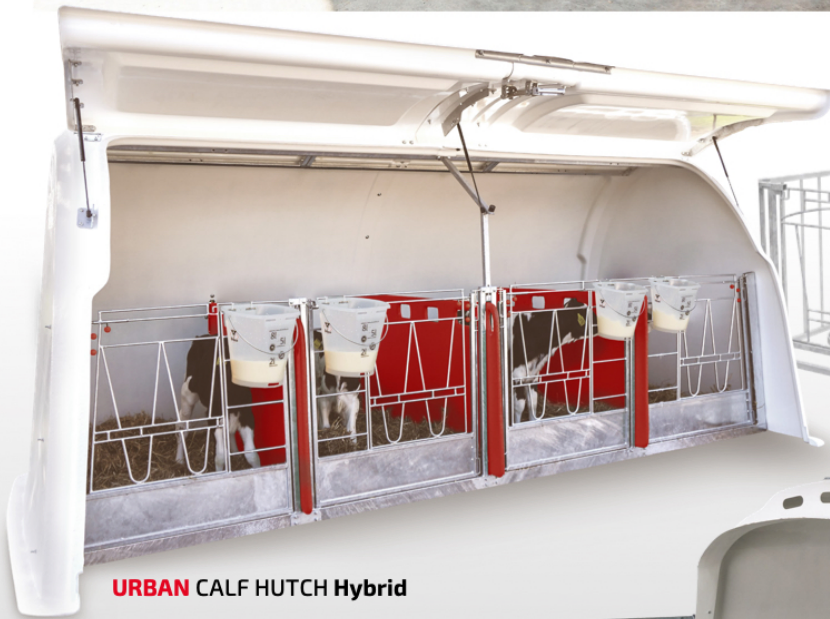

URBAN CALF HUTCH Hybrid



URBAN CALF HUTCH L



URBAN CALF HUTCH XL



URBAN – YOUR PARTNER FOR A SUSTAINABLE REARING.





We are always available online!

On our website you will find further latest news and information about our products.



More exciting stories and videos we regularly post on our social media channels.

Visit us also on:



www.youtube.com/user/calffeeding



www.flickr.com/photos/urbanonline



www.facebook.com/urbanonline



www.instagram.com/urbancalffeeder

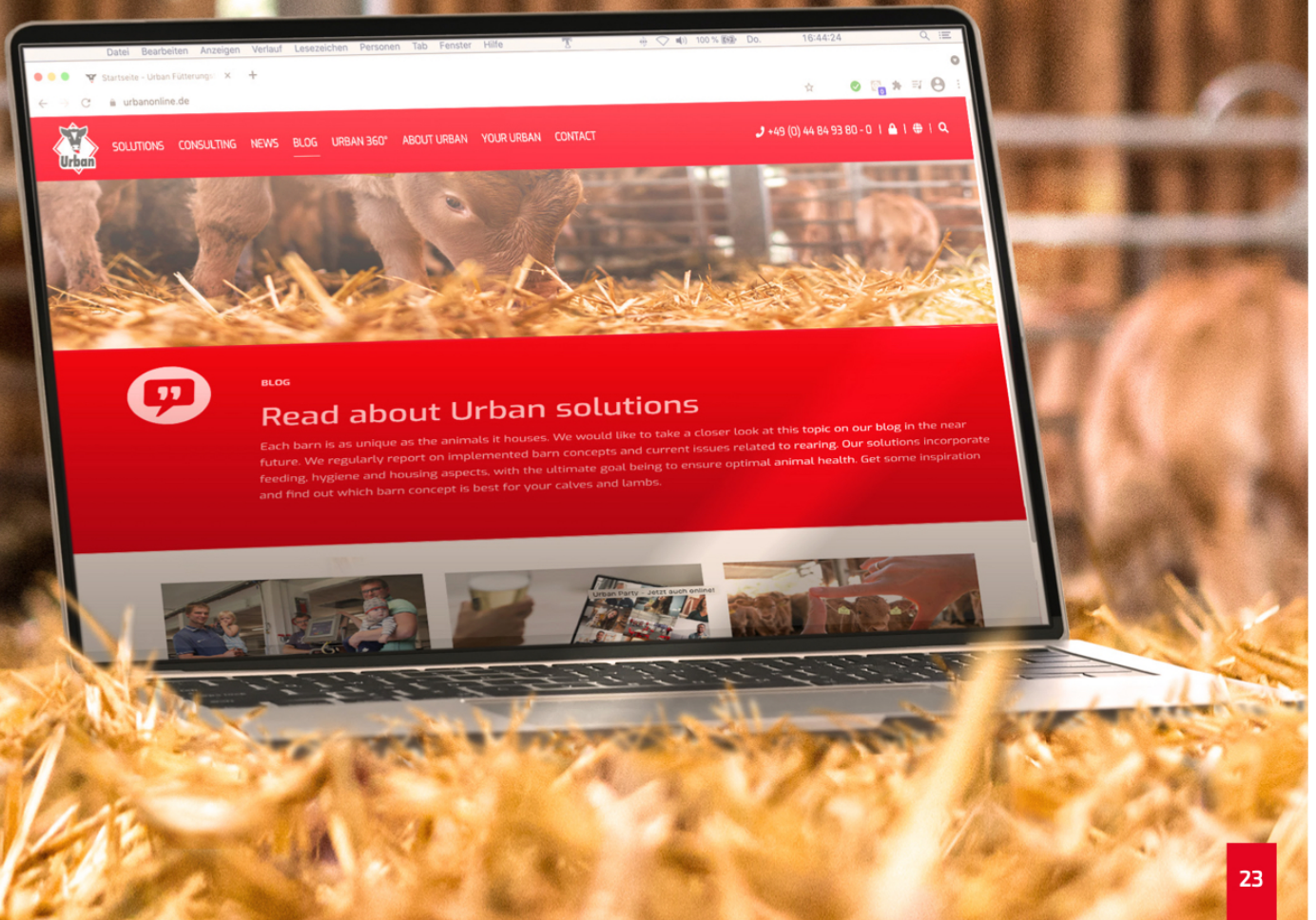



Urban GmbH & Co. KG

Auf der Striepe 9

D-27798 Wüstring

+49 (0) 44 84 93 80 - 0

info@urbanonline.de

www.urbanonline.de

© 2022 Urban GmbH & Co KG, Technical modifications and errors excepted.